

LEHNER RESIDENCE

2115 Highland Drive  
Elm Grove, Wisconsin 53122

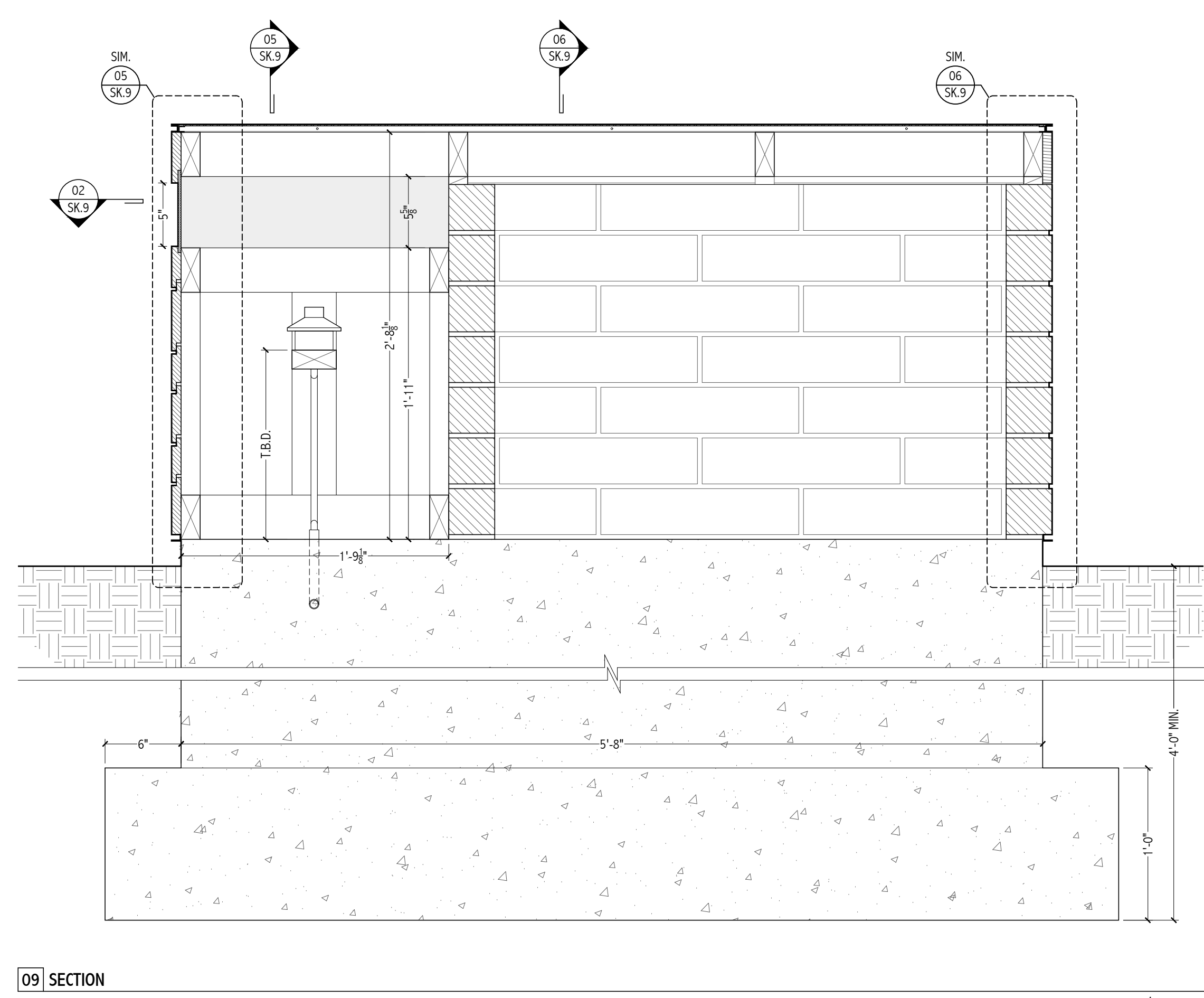
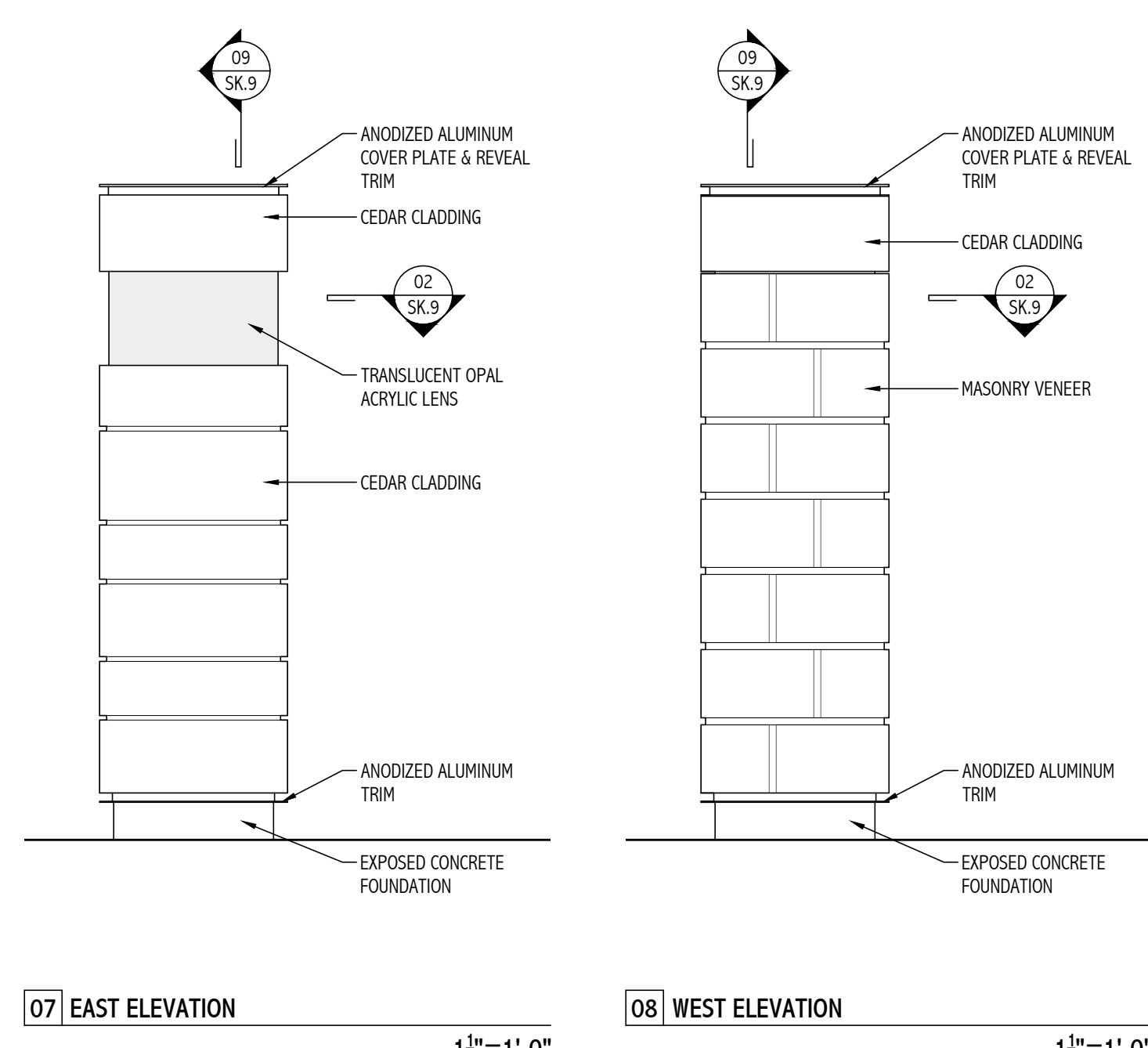
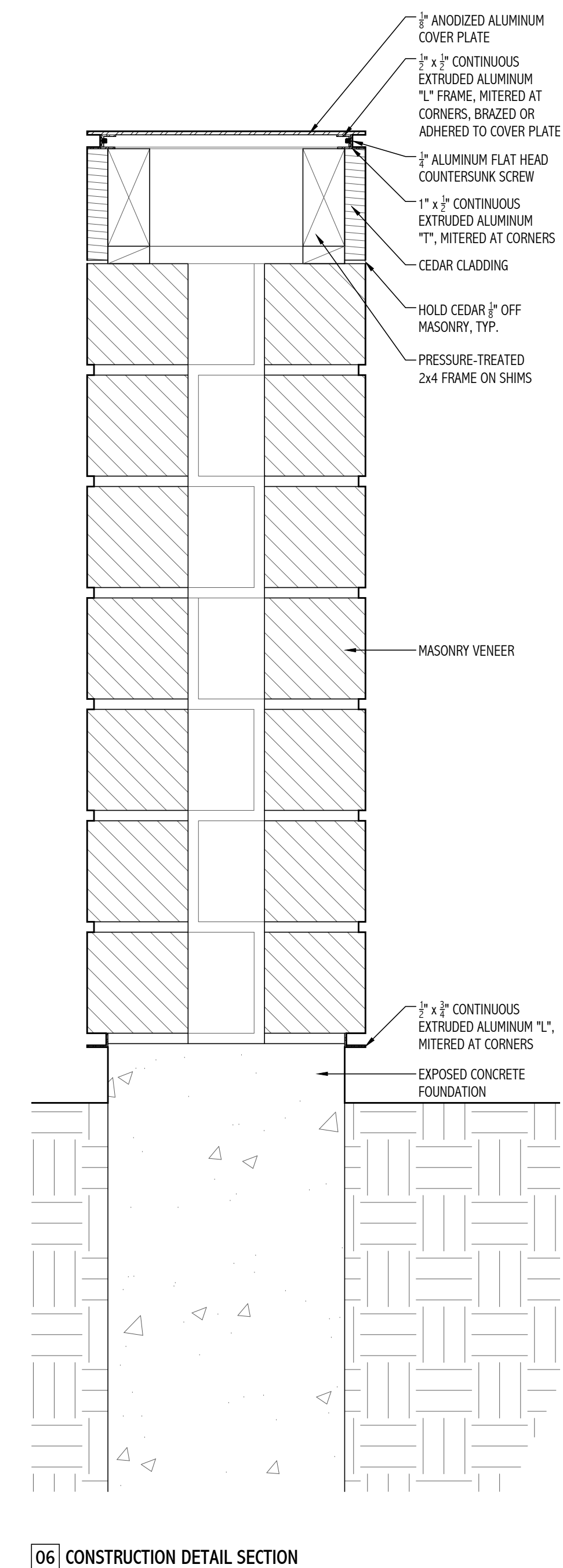
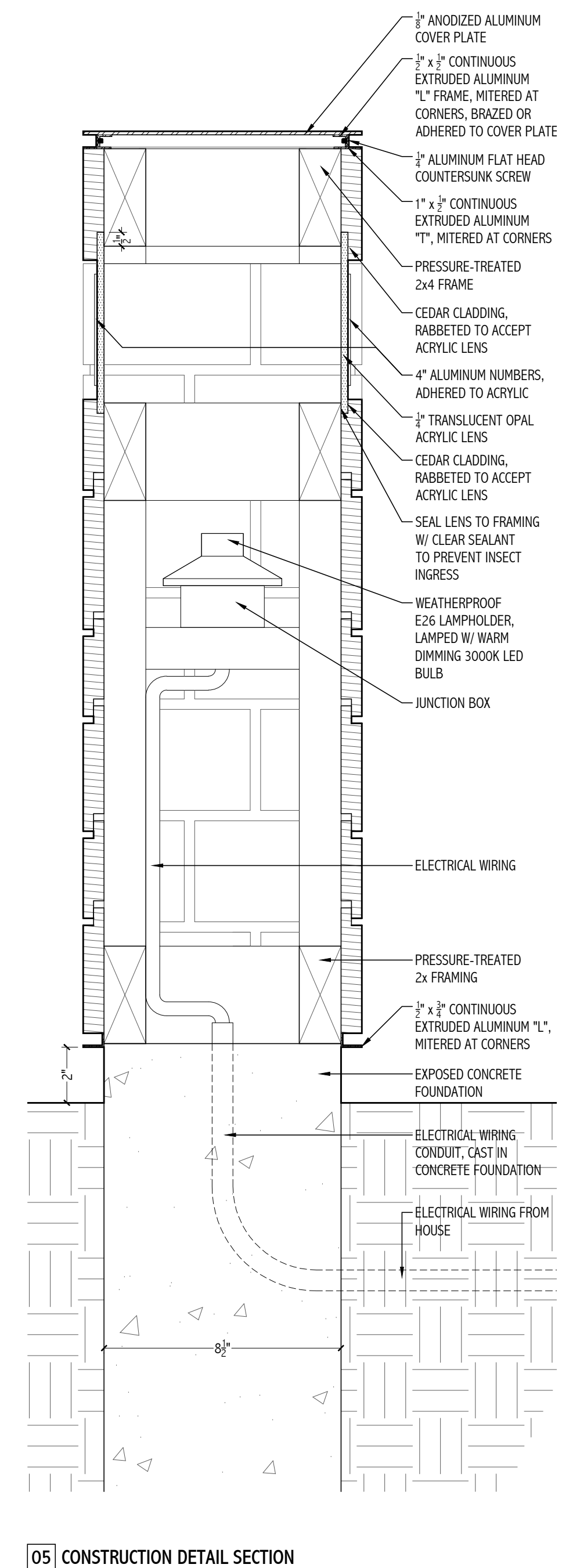
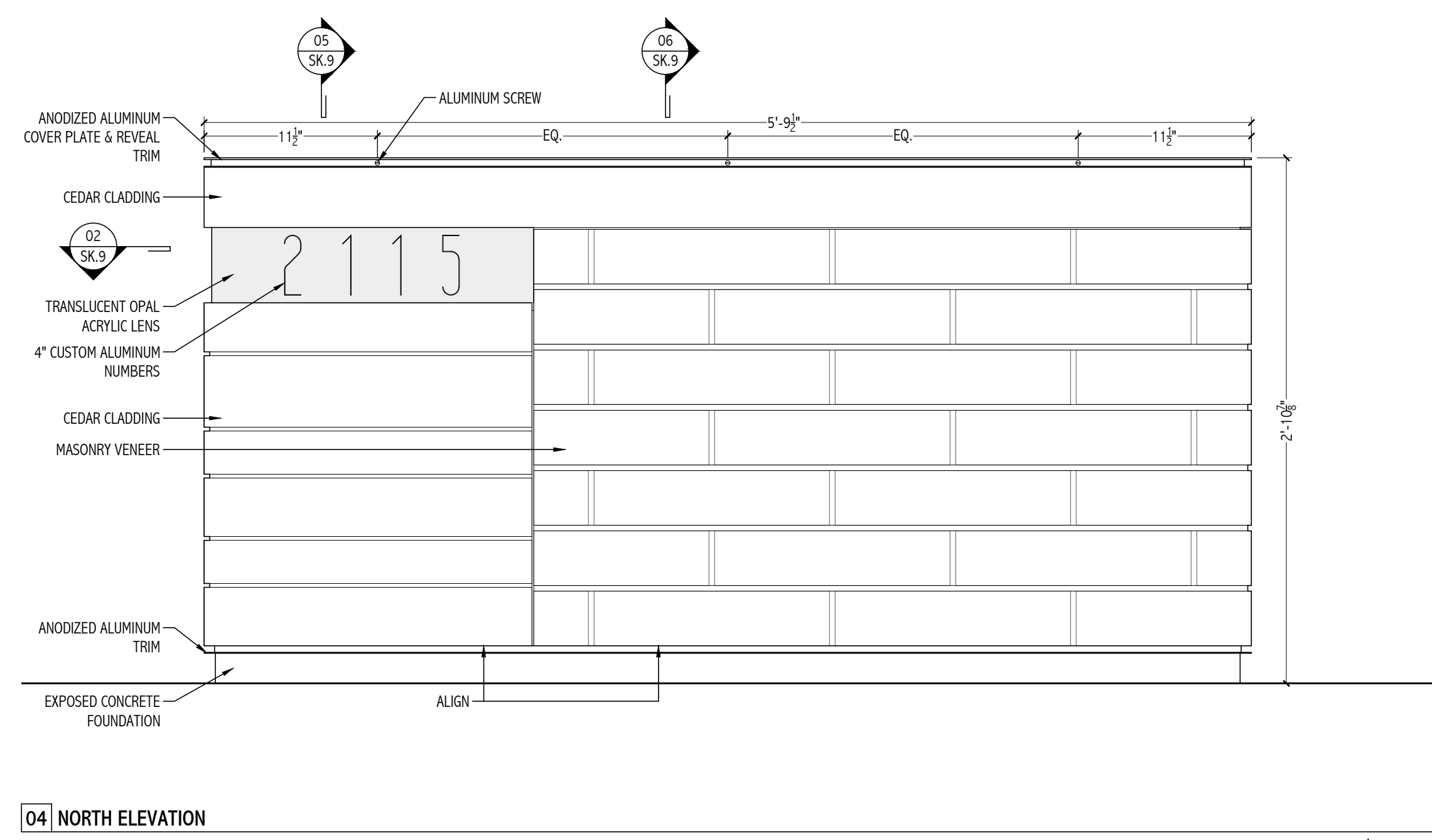
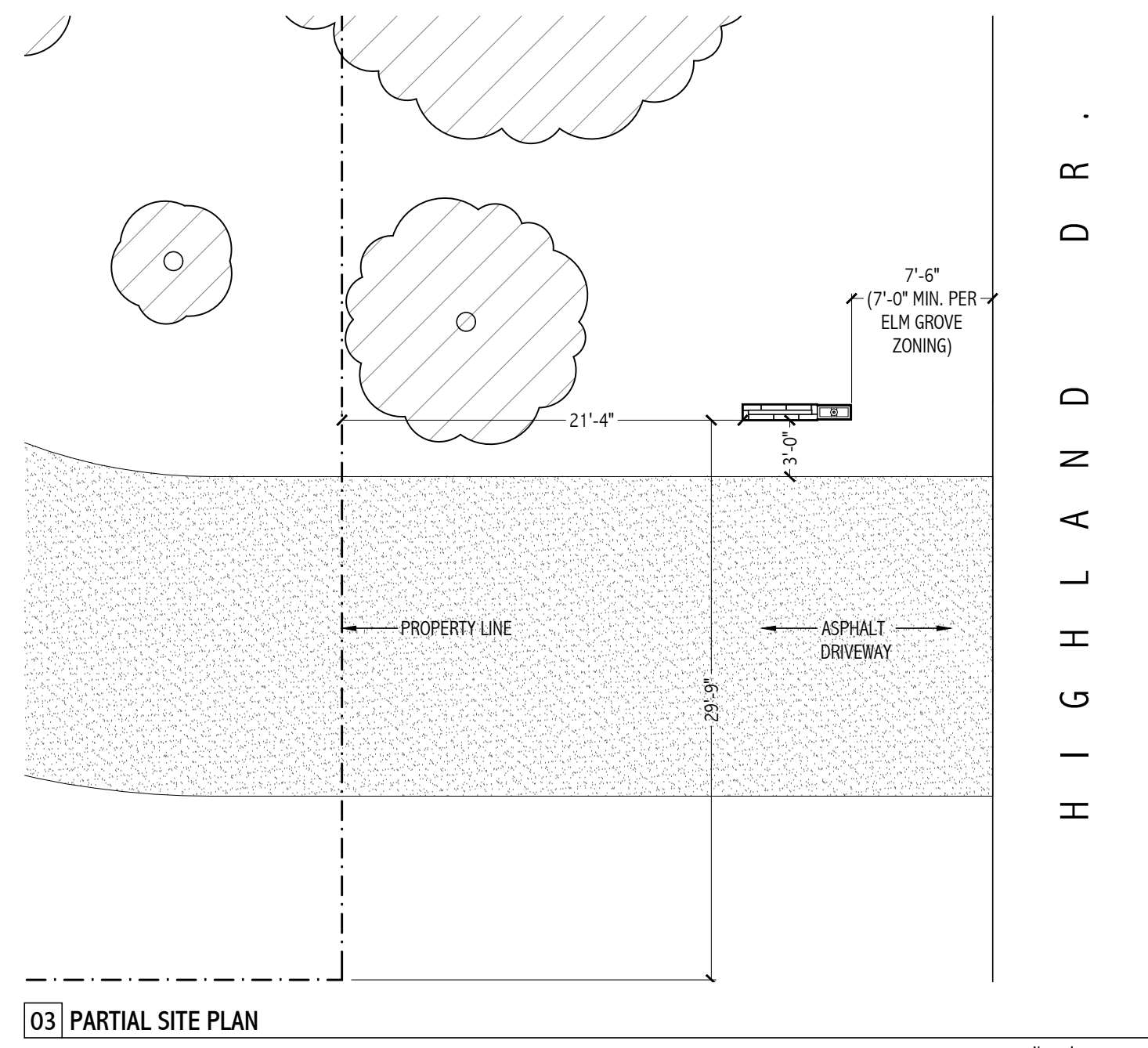
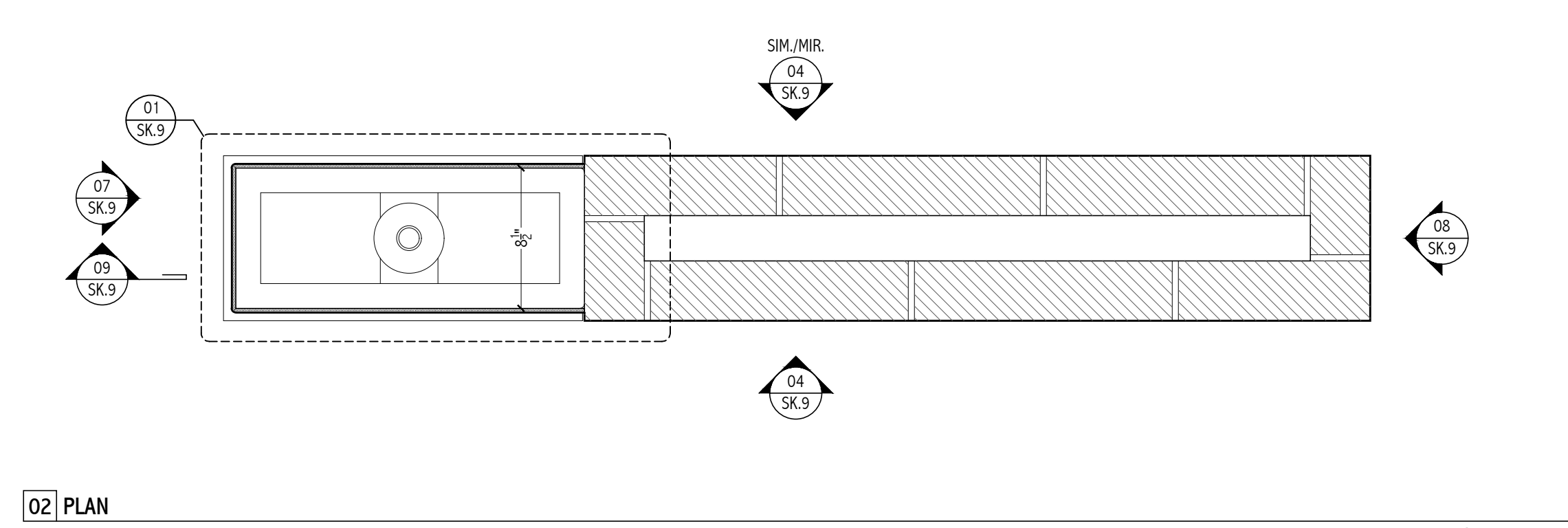
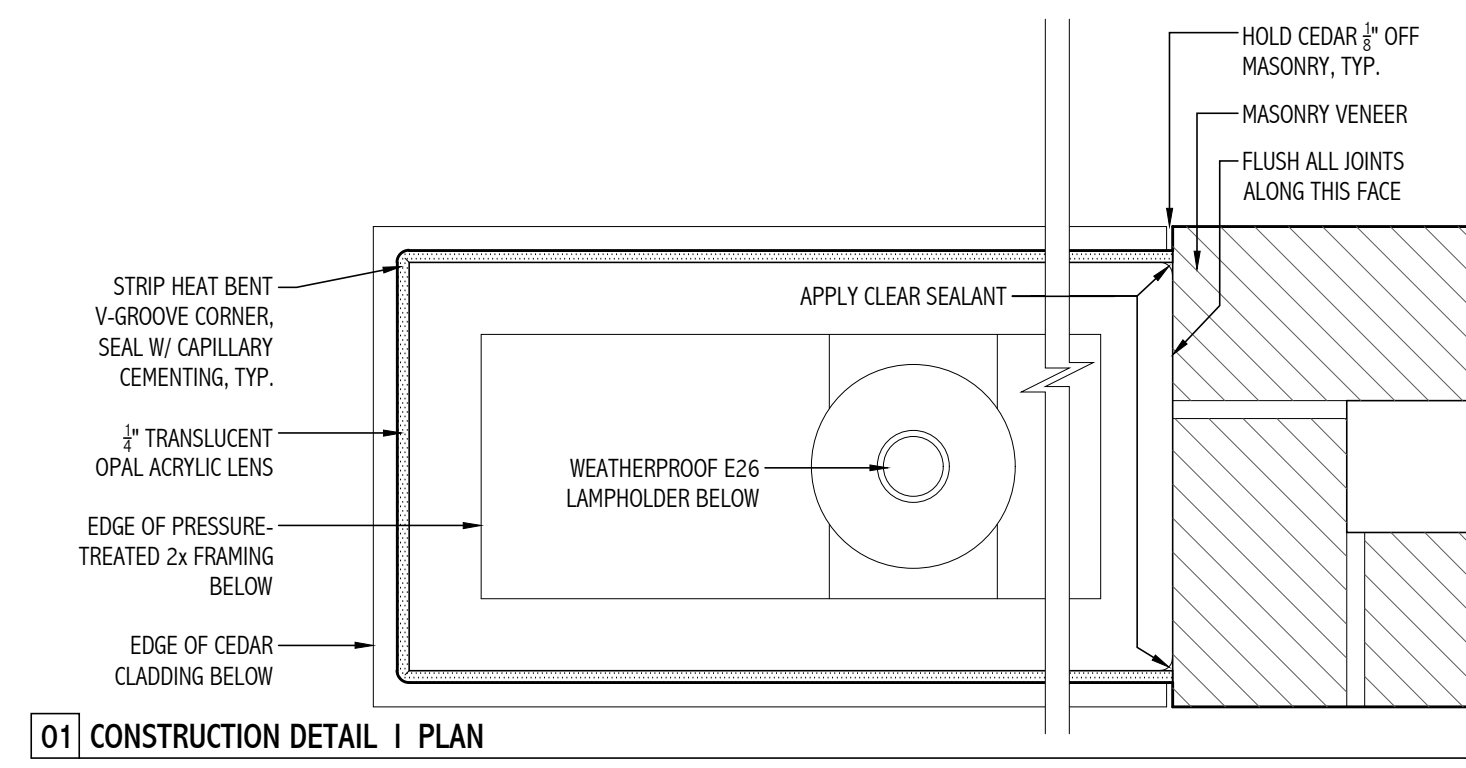

REFER TO THE CONSTRUCTION DOCUMENTS  
DATED 09.12.2017 FOR FULL SPECIFICATIONS

ISSUANCE AND REVISIONS  
03.11.19 - ISSUED FOR PRICING

DATE: 03.11.2019

ADDRESS MARKER

**SK.9**